



Seeking alternative lice and AGD control: FW snorkel cages

Daniel Wright

Frode Oppedal, Tim Dempster, Lars Stien, Lena Geitung, Egil Karlsbakk

Institute of Marine Research | University of Melbourne | University of Bergen

Chemical-free lice barrier cages are here

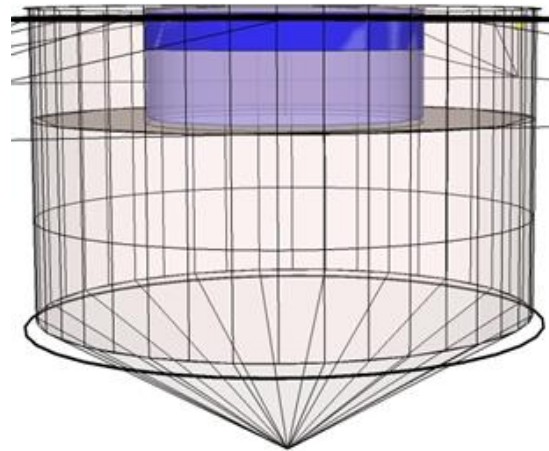

Snorkel cage

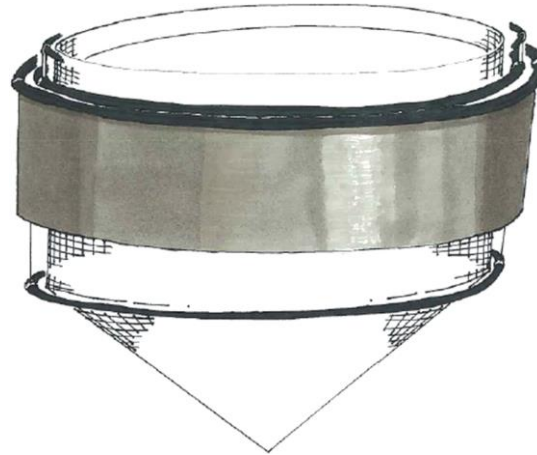

Skirt cage

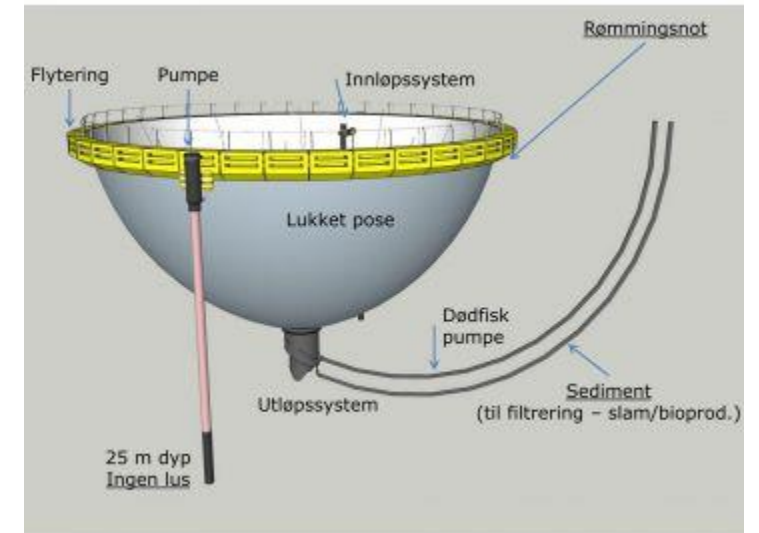

Enclosed cage

Stien et al. (2012) Aquac Eng
Stien et al. (2016) Aquaculture
Nilsen et al. (2016) Aquaculture

But barriers may worsen AGD outbreaks

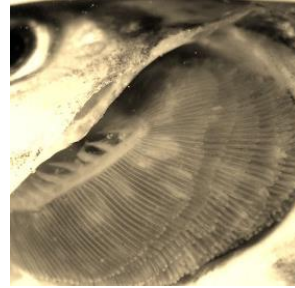

AGD scores ≥ 1:	Control	Snorkel	Control	Snorkel
	0%	100%	14%	100%

FW snorkel an option to control lice and AGD

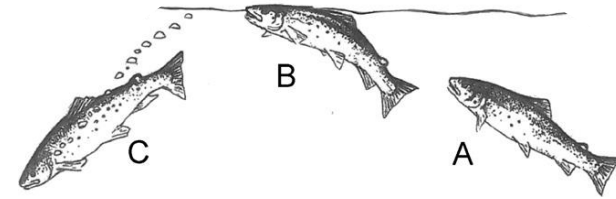
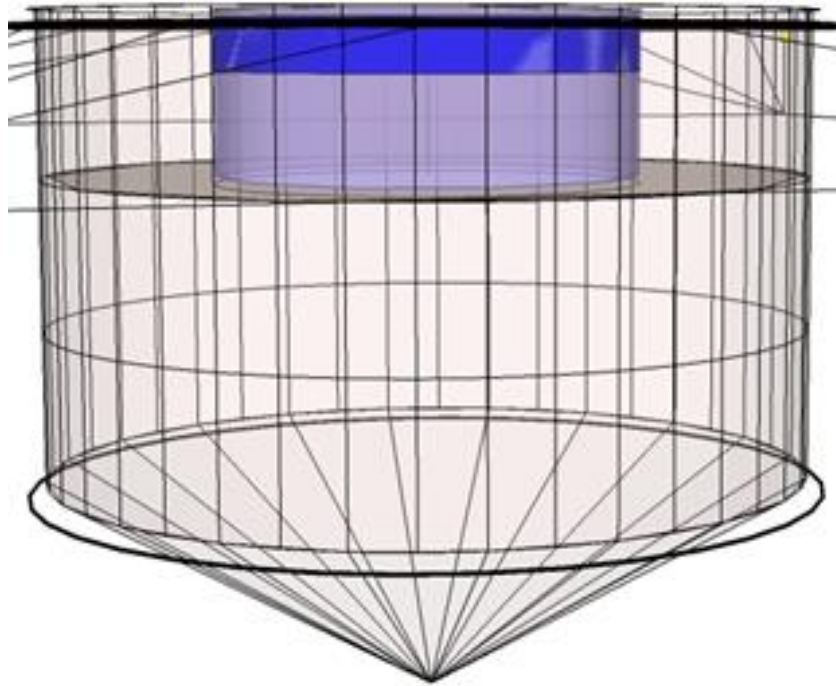

Korsøen et al. (2012) Aquac Eng

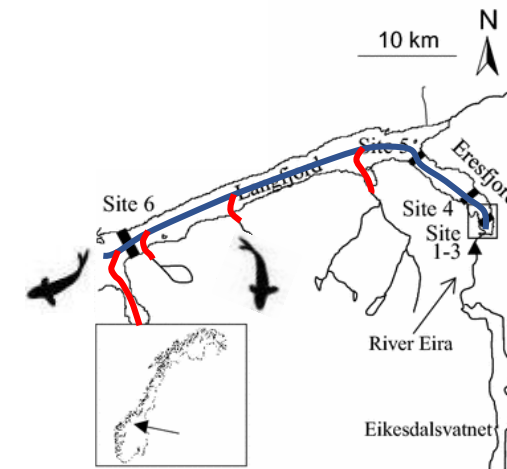

Mitamura et al. (2017) Anim Biotelem

AGD and lice in freshwater

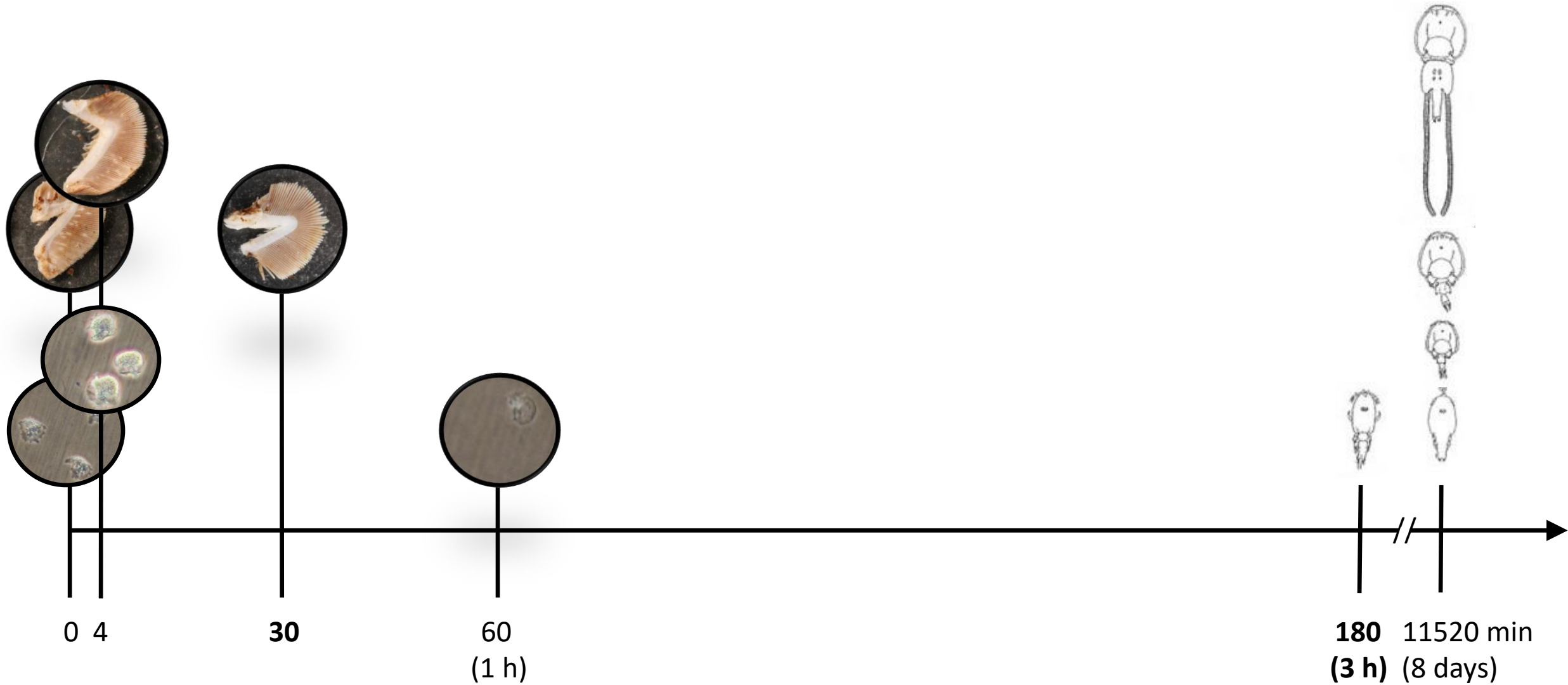

Commercial cages: FW snorkel testing

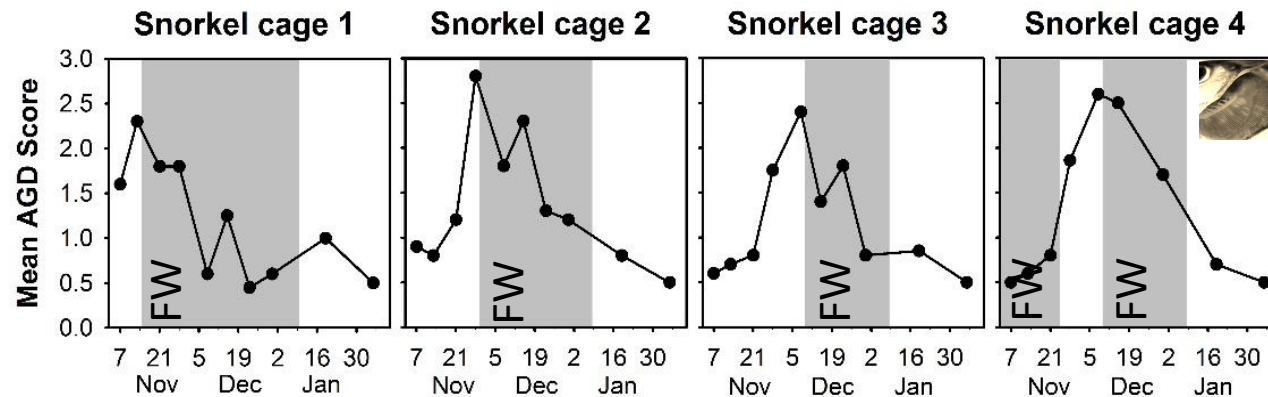
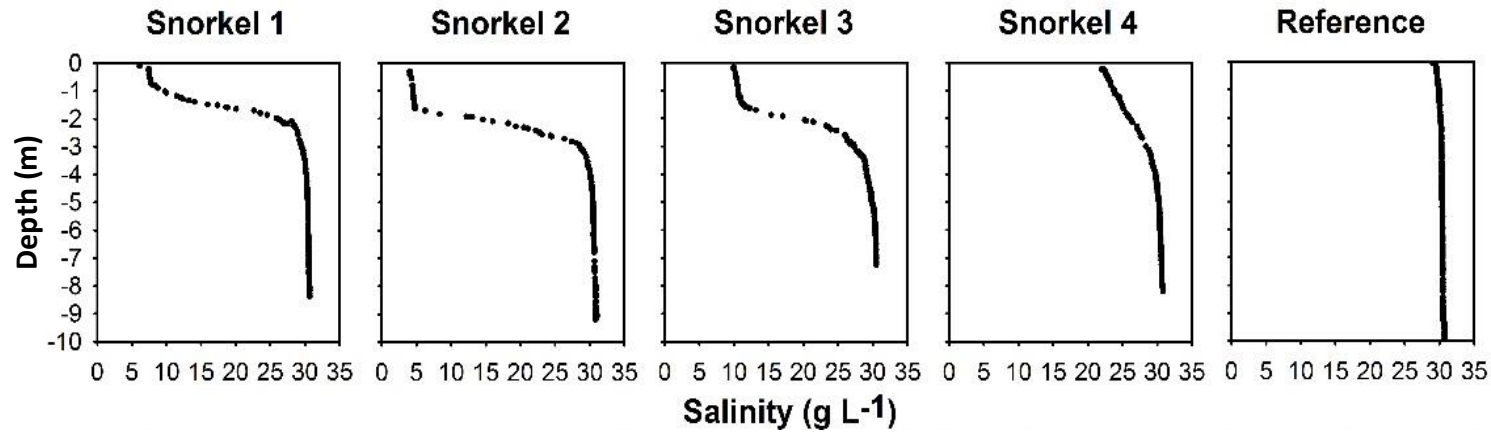

Research cage experiment: AGD and lice

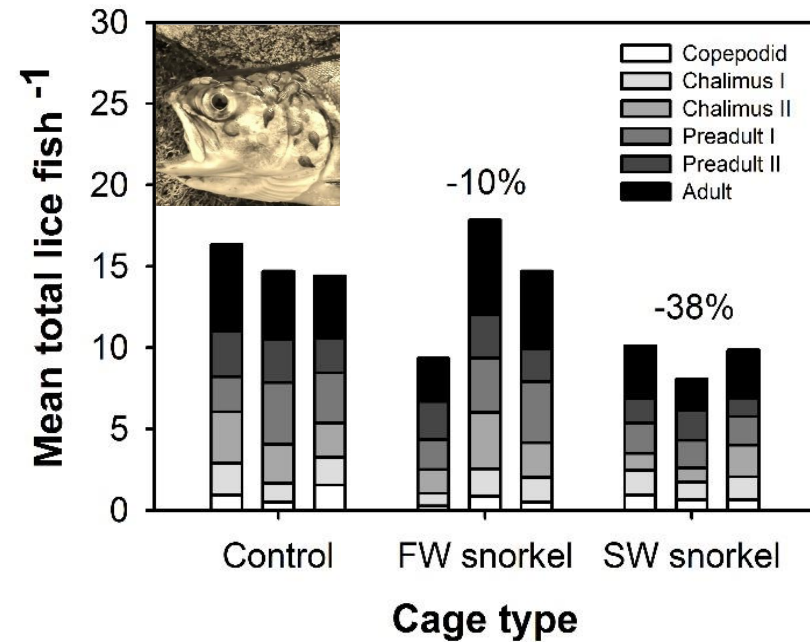
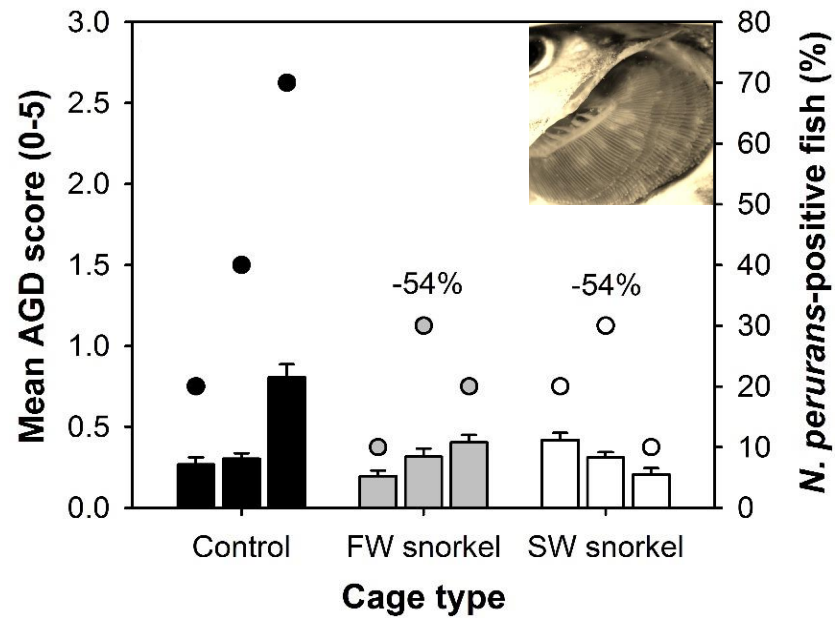

Research cage experiment: Fish depth

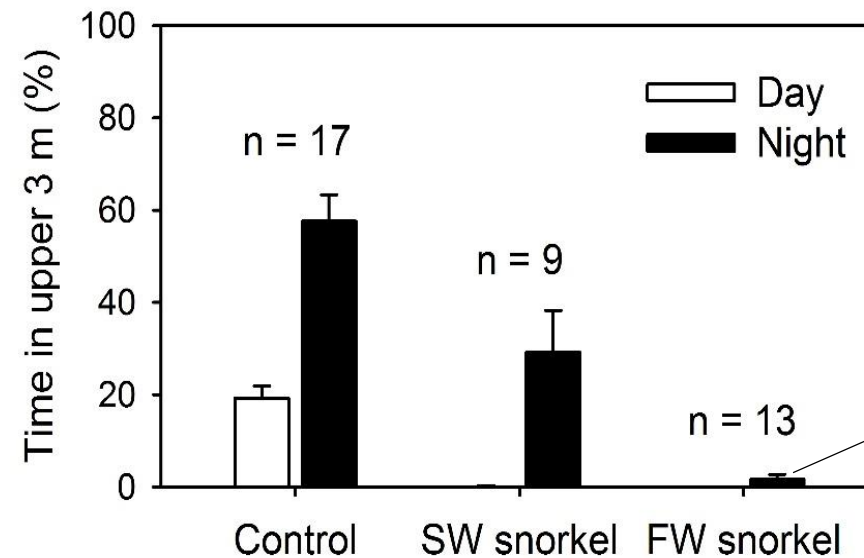

17 min day⁻¹
(or 7 min day⁻¹
if excluding 1 fish)

Research cage experiment: Fish jumps

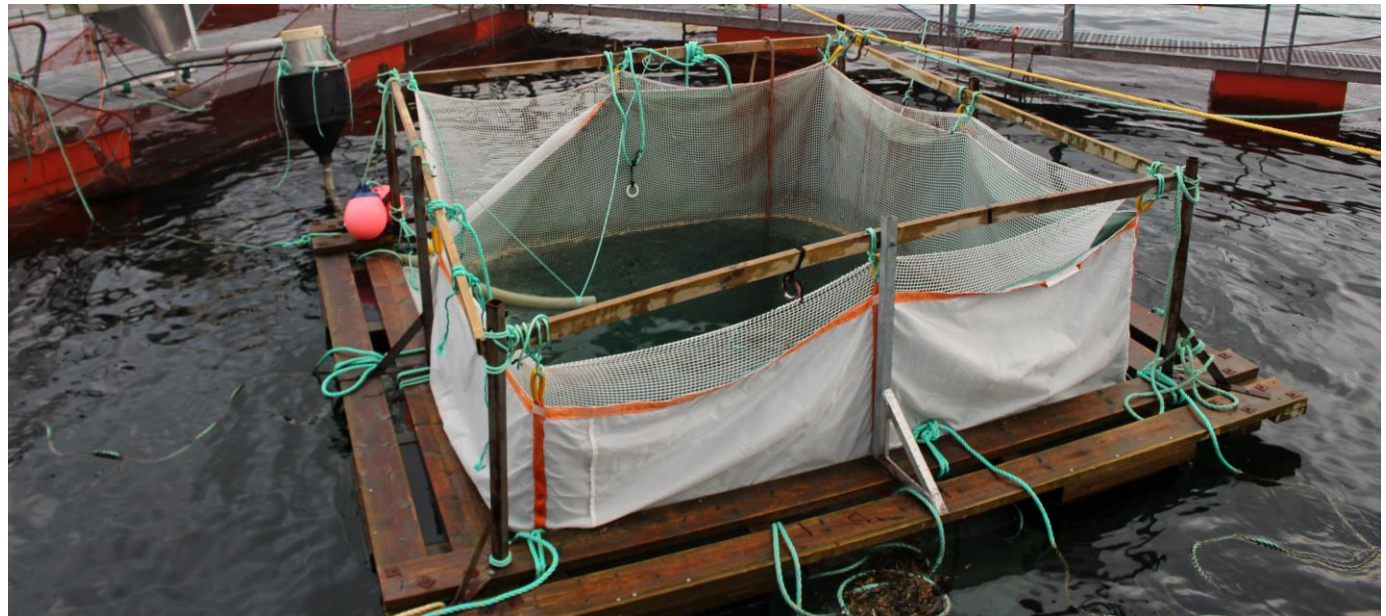
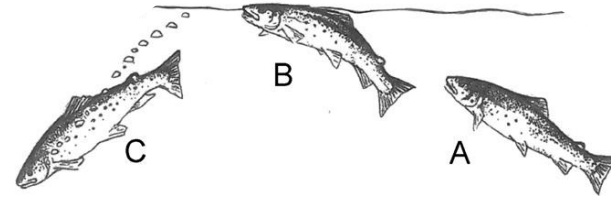
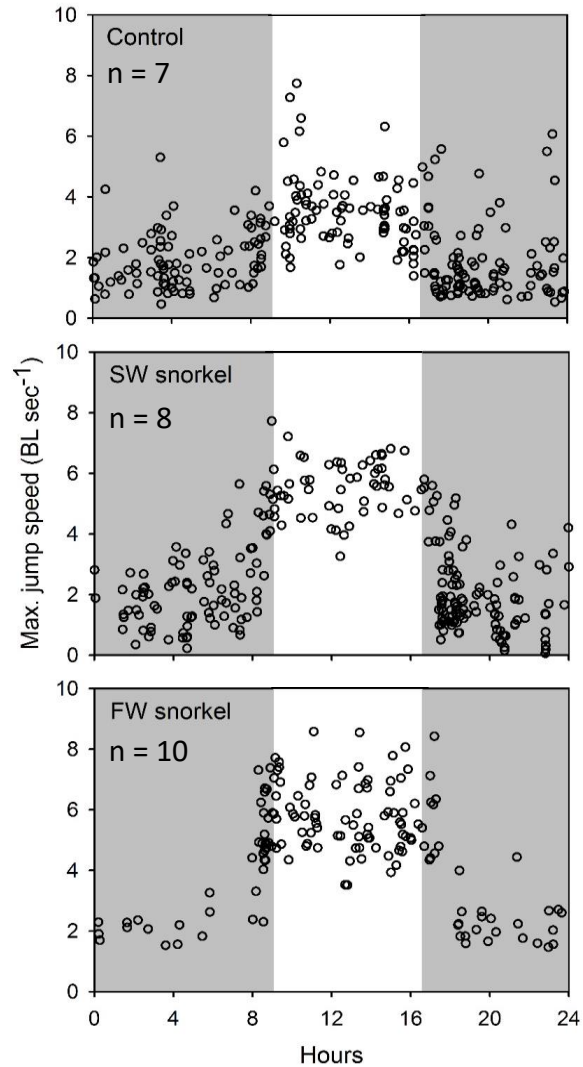

Conclusions and future directions

- Short, frequent FW doses are a viable alternative
- FW avoidance is a thing
- May force salmon below snorkels, increasing lice infestations
- FW snorkel effects may depend on cage scale

